

Pump TKA32/80

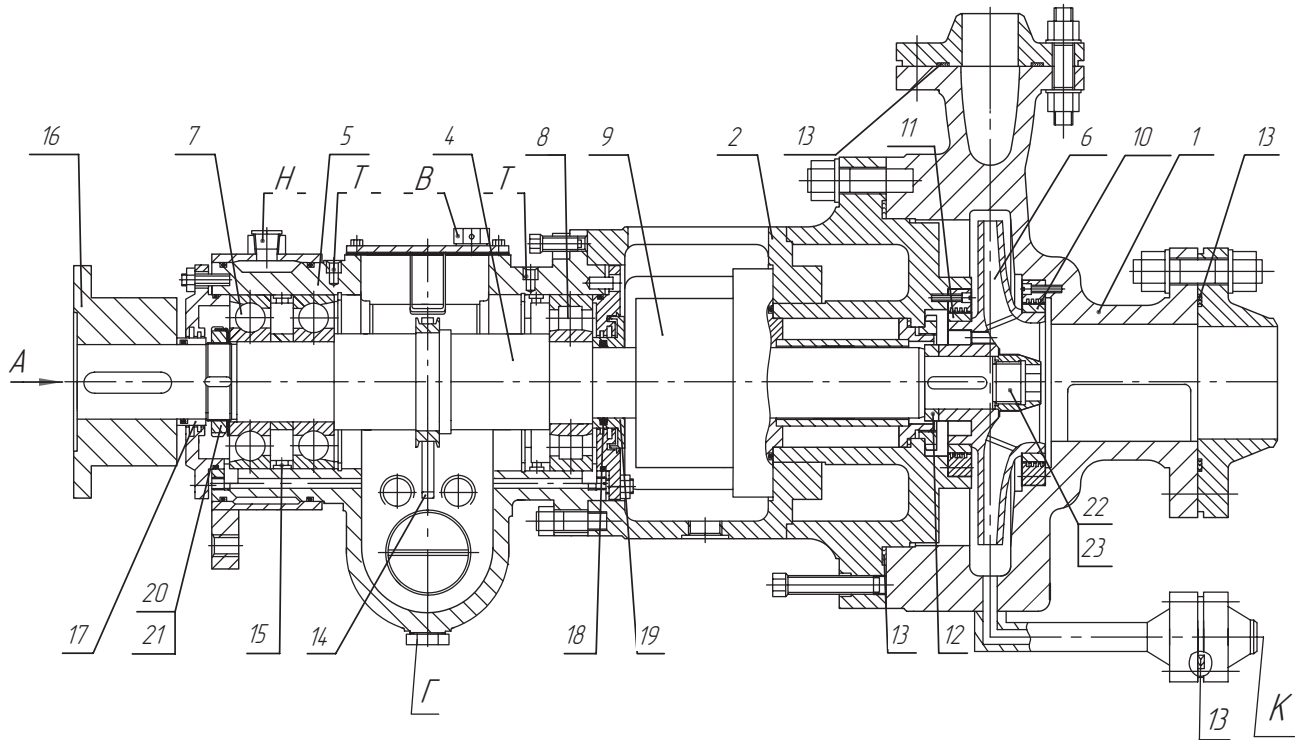

- | | |
|---------------------------------|------------------------------|
| 1. Pump casing; | 13. Spiral-wound gaskets; |
| 2. Pump cover; | 14. Oil supply ring; |
| 4. Shaft; | 15. Complete set of washers; |
| 5. Bearing housing; | 16. Halfcoupling; |
| 6. Impeller; | 17. Barrel; |
| 7. Radial-thrust ball bearings; | 18. Seal rings; |
| 8. Rolling radial bearing; | 19. Baffle ring; |
| 9. Shaft sealing; | 20-21. Nut-washer; |
| 10-11. Sealing rings (rotary); | 22-23. Nut-washer (rotary). |
| 12. Barrel; | |

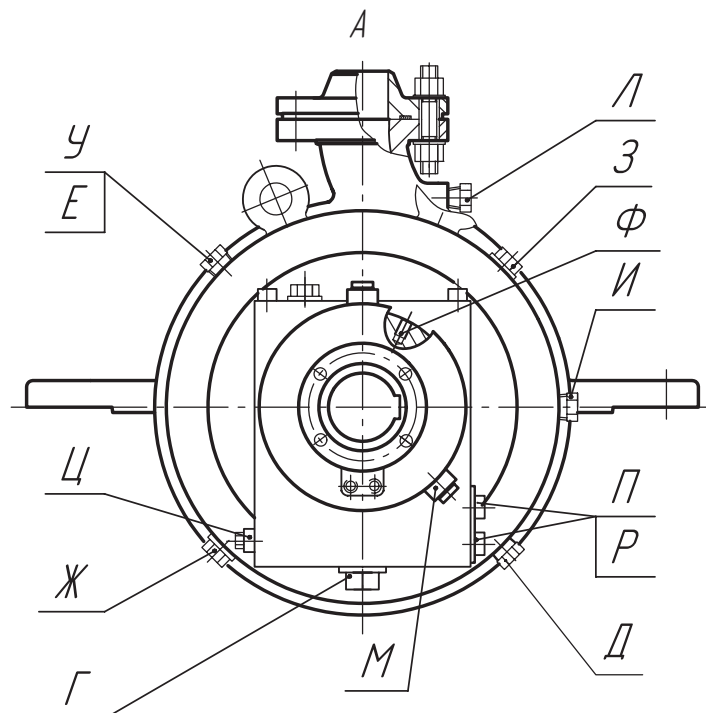

Performance of pump TKA32/80

$n = 2950 \text{ rev/min}$ $\gamma = 0,01 \text{ cm}^2/\text{s}$ $\rho = 1000 \text{ kg/m}^3$

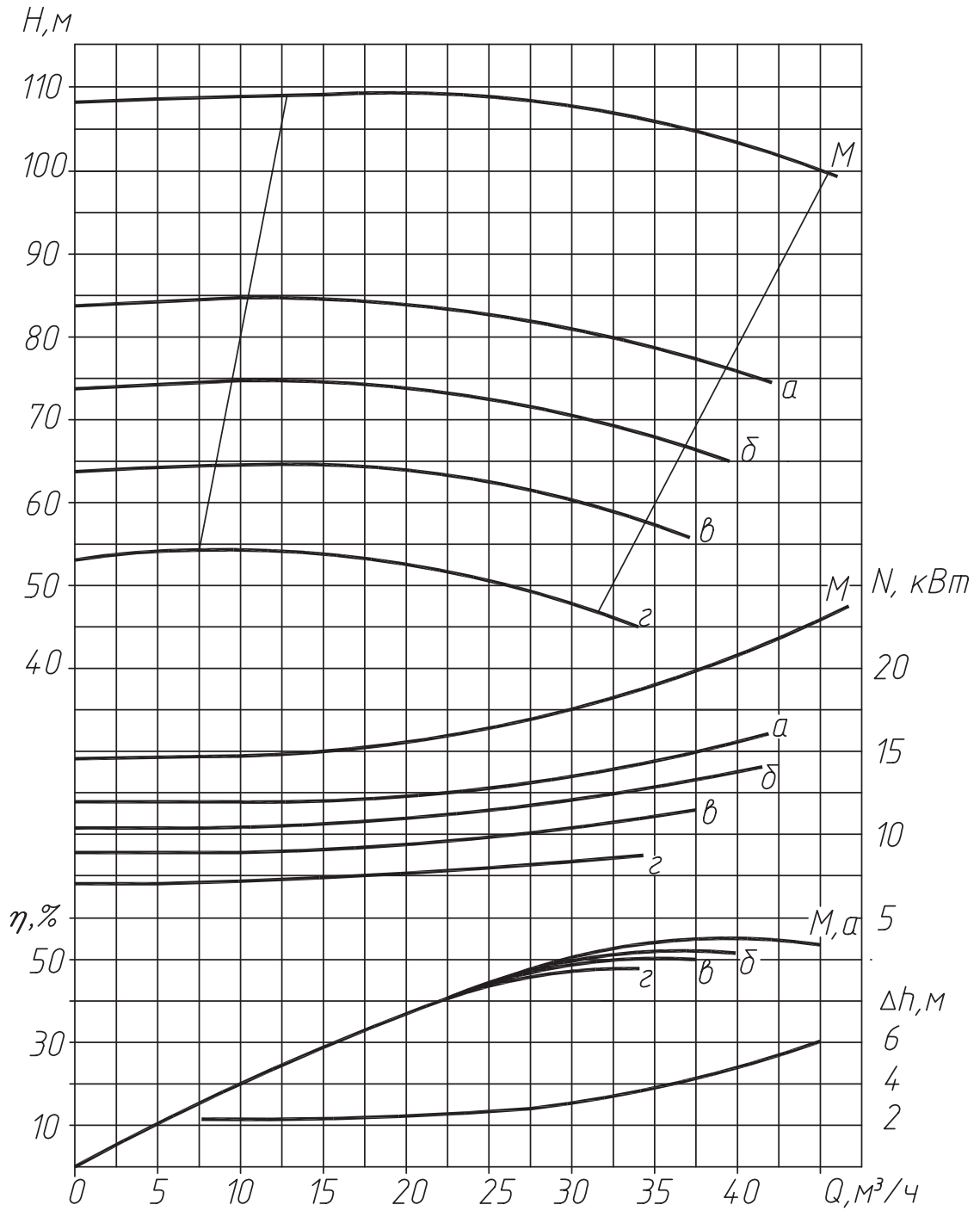

Performance of pump TKA32/80

$n = 1475 \text{ rev/min}$ $\gamma = 0,01 \text{ cm}^2/\text{s}$ $\rho = 1000 \text{ kg/m}^3$

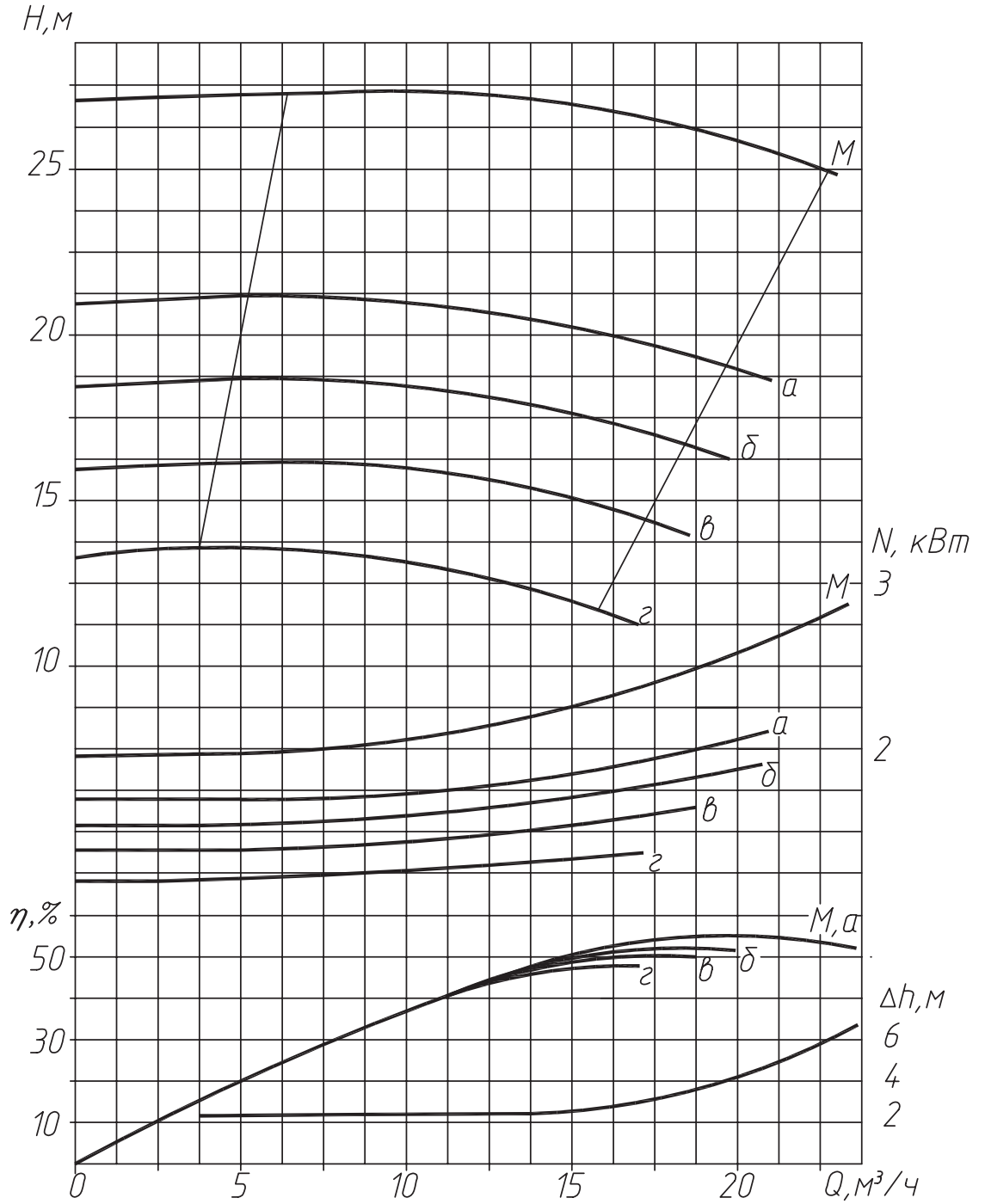

Outline drawing of pump TKA32/80

Welded frame

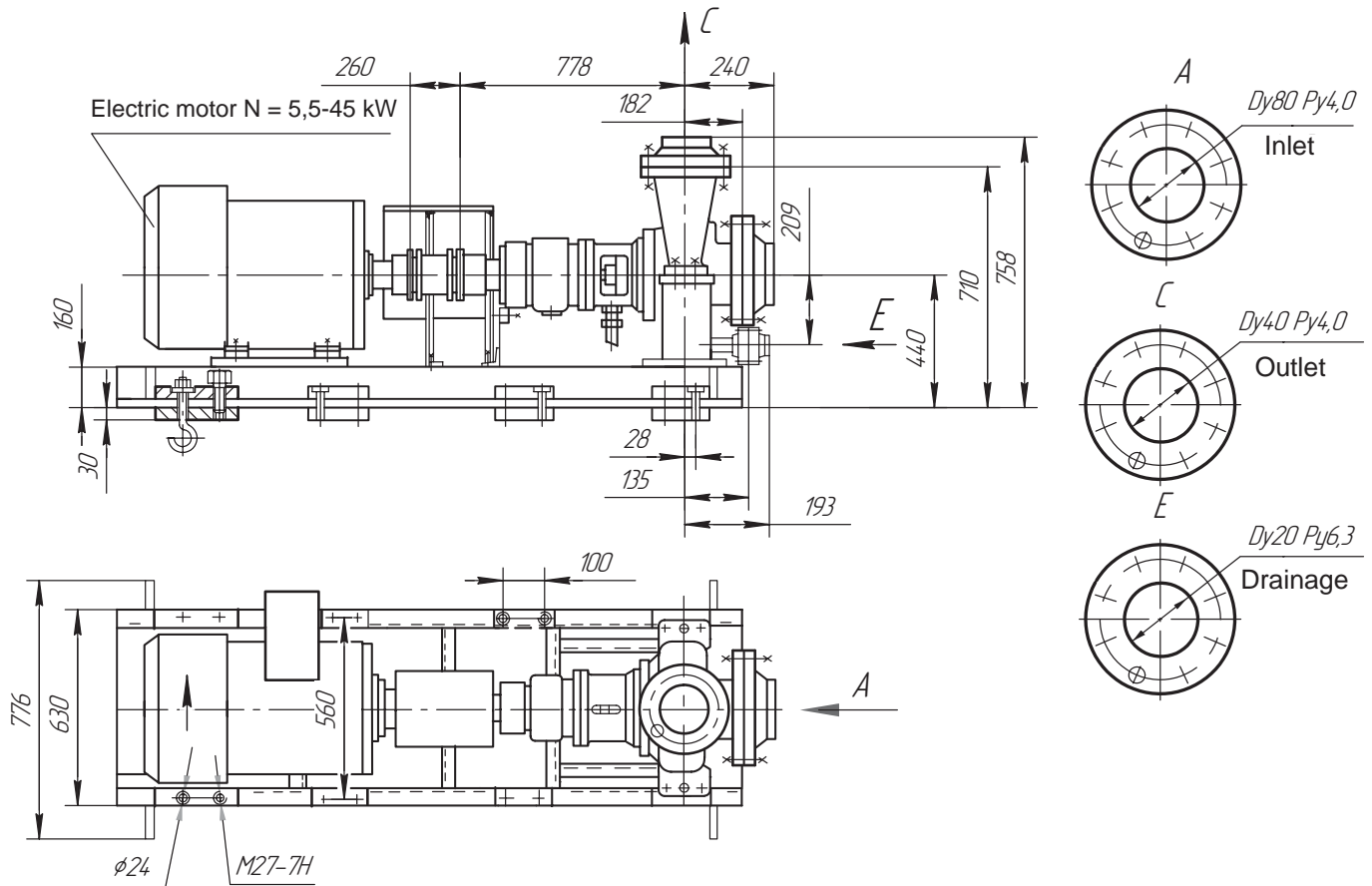

Cast plate

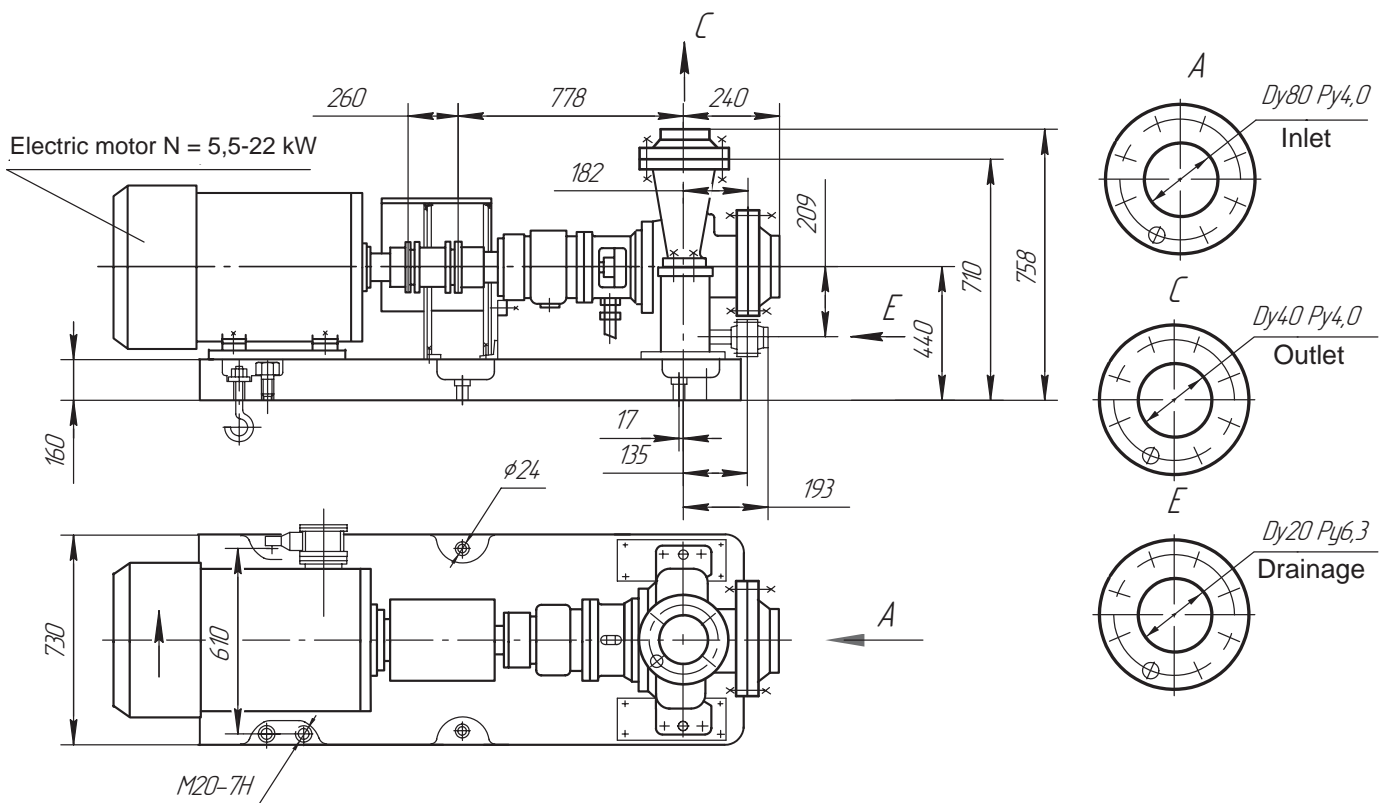

Note: Frame (plate) length dimension, quantity and location of holes for foundation bolts subject to clarification for specific type of electric motor.